

Panels and Patchbays

75Ω Video Patchbays



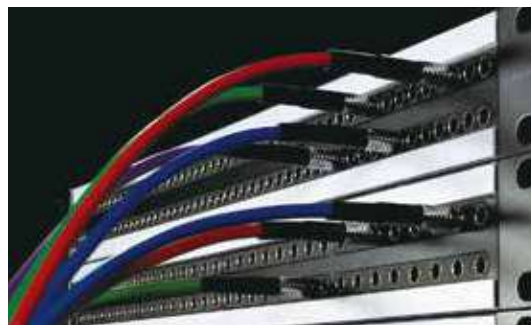

Overview

Video patchbays, as a backup or a final means for safety in a routing system, often face high demand on stable and constant patching connections and contacts. Over the decades, Canare has focused on these essentials and has developed the solutions for the latest video format such as 4K/8K.

The following table will help finding the right panels for you.



Product Finder









Page	74	75	76	77	78
Applications	4K/8K 12G-SDI 6G-SDI	4K/8K 12G-SDI 6G-SDI	2K/4K 3G-SDI HD-SDI	2K/4K 3G-SDI HD-SDI	2K/4K 3G-SDI HD-SDI
Patchbays					
	32MCKA-ST*	32SVK-ST	48MC*	32MD-ST*	2xDV*
Channels	32	32	48	32	20, 24, 26
Rack Unit	1RU, 1.5RU, 2RU	1RU, 1.5RU	1RU	1RU, 2RU, 4RU	1RU, 2RU
Jacks					
	MCVJKA-STW/S	SVJK-S/L	MCVJ-W/S	MDVJ-STW/S	DVJB-W/S
Self Terminating	Yes	No	Yes	Yes	Yes
Front	Canare Micro	Canare Single	Canare Micro	Mini-WECO	WECO
Rear	BNC	BNC	DIN 1.0/2.3	BNC	BNC
NET Weight (approx.)	2.8 kg	1RU : 1.7 kg 1.5RU : 2.4 kg	2.3 kg	1RU : 2.9 kg 2RU : 3.9 kg 4RU : 8.0 kg	20DV : 2.4 kg (1RU) 24DV : 2.7 kg (1RU) 26DV : 2.8 kg (1RU)
SMPTE	ST 2081-x ST 2082-x		ST 292 ST 424 ST 425-x		
Features	Mechanical switch with Dust-proof Shutter	MUSA style Hassle-free patching	Mechanical switch with Dust-proof Shutter	100% sealed rotary switch	100% sealed rotary switch
Patch Cord/U-Link					
	MCVPC**	SVP-ULK SVP**	MCVPC**	MVPC**	VPC**

WECO : Western Electric Company (W.E. standard)

Technical Note

Dual Video Jack Normalling Chart

There are two types of dual video jacks: Normal Through and Straight Through. In Canare, these are identified at the end of the model name, W means the former and S means the latter. The following chart explains the differences between two types.

W type (Normal Through)				S type (Straight Through)			
Video Port: No Patch		BNC Port: Signal thru as Arrowed	Signal routes between top and bottom BNC without the use of Video plugs.	Video Port: No Patch		BNC Port: Both Signal Terminated	Two independent single jacks in a dual housing.
Video Port: Patch Upper		BNC Port: Lower Terminated	Inserting a Video Patch Cord into front "upper" port automatically terminates signal path into the lower 75Ω load.	Video Port: Patch Upper		BNC Port: Lower Terminated	Inserting a Video Patch Cord into front "upper" port automatically terminates signal path into the lower 75Ω load.
Video Port: Patch Lower		BNC Port: Upper Terminated	Inserting a Video Patch Cord into front "lower" port automatically terminates signal path into the upper 75Ω load.	Video Port: Patch Lower		BNC Port: Upper Terminated	Inserting a Video Patch Cord into front "lower" port automatically terminates signal path into the upper 75Ω load.
Video Port: Patch Both		BNC Port: Signal thru as Arrowed	Inserting Video Patch Cords into both front ports inputs and/or outputs signal.	Video Port: Patch Both		BNC Port: Signal thru as Arrowed	Inserting Video Patch Cords into both front ports inputs and/or outputs signal.

75Ω Staggered Video Patchbays

The next-generation 12G-ready video patchbays with newly developed staggered dual video jacks.

■ Patchbays **12G-SDI**

Model	Panel Size	Loaded Video Jacks
32MCKA-ST New	1RU	32 × MCVJKA-STW
32MCKA-STs New	1RU	32 × MCVJKA-STs
32MCKA-ST-1.5U New	1.5RU	32 × MCVJKA-STW
32MCKA-ST-1.5U New	1.5RU	32 × MCVJKA-STs
32MCKA-ST-2U New	2RU	32 × MCVJKA-STW
32MCKA-STs-2U New	2RU	32 × MCVJKA-STs

Standard panel color: Black. Available in 5 colors. see page 79.

Key Features and Benefits

- 12G-SDI: SMPTE ST 2082-1 fully compliant
- Refined the entire performance for 12G applications
- Lightweight video jacks with simple structure.
- Dust-proof shutter
- New 1.5RU and 2RU panels:
Finger removal and wider designation strip



Note: Be sure to use with Canare Micro Video Patch Cords.

■ Dual Video Jacks

Model	Description	Rear Jacks
MCVJKA-STW New	Normal through, Staggered rear jacks	BNC
MCVJKA-STs New	Straight through, Staggered rear jacks	BNC

■ Micro Video Plug

Model	Suitable Cable	Boot	Die Set
MCVP-C25HW	L-2.5CHWS	—	TCD-D253F

*Standard package: 20 pcs

*The plug is specifically designed for MCVJ and MCVJKA jacks.

■ Accessories

Model	Description
MCVPC**	Canare Micro patch cords (see page 83)
BCJ-MCVP New	BNC (female) to Micro Video plug conversion adapter (10 pcs)
BET-BNC New	BNC extraction tool (see page 47)
PH50B	Patch cord holder for MCVPC**
MCVJ-DC	Dust cap for MCVJKA (black, 100 pcs)
MJ2-M32CKA-U-*** New	Unloaded panels (see page 81)

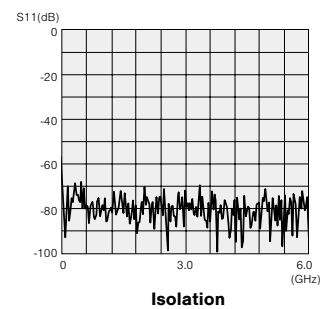
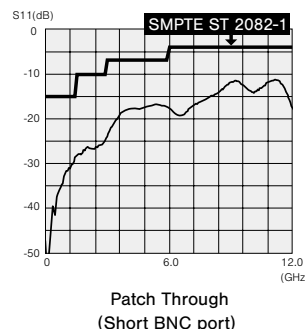
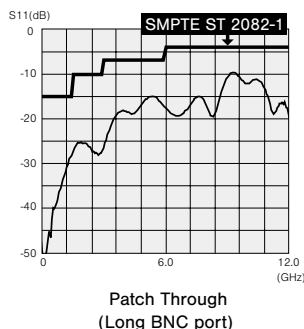
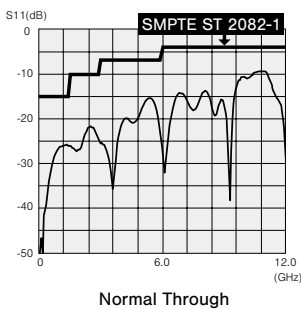

Return Loss for MCVJKA-STW



32MCKA-ST

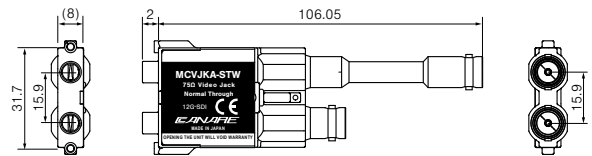
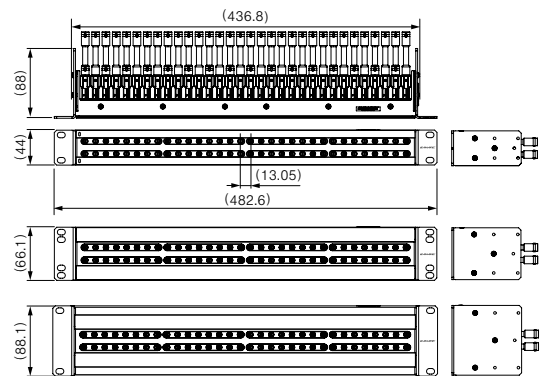

MCVP-C25HW



BCJ-MCVP

■ Return Loss & Isolation

Model	MCVJKA-STW	MCVJKA-STs
RL	BNC-BNC: Normal Through	—
	BNC-Video: Patch Through	15 dB or greater @ 1.5 GHz 10 dB or greater @ 3 GHz 7 dB or greater @ 6 GHz 4 dB or greater @ 12 GHz
	BNC-Self Termination	15 dB or greater @ 1.5 GHz 10 dB or greater @ 3 GHz 7 dB or greater @ 6 GHz 4 dB or greater @ 12 GHz
Isolation	45 dB or greater @ 6 GHz	45 dB or greater @ 6 GHz

Technical Trend

Fiber-Optic Systems

Connectors

Cables

Panels & Patchbays

Multichannel Systems

Cable Assemblies

Panels and Patchbays

75Ω Video Patchbays

75Ω Single Video Patchbay

The true 12G-SDI video patching system: Canare exclusive 12G capable single jacks, convenient looping plug, flexible patch cords, and 75Ω termination video plug. This MUSA style solution exceeds 4K/8K UHD requirements. 1RU, 1.5RU, or 2RU panel options available.

■ Patchbay **12G-SDI**

Model	Panel Size	Loaded Video Jacks
32SVK-ST	1RU	32 × SVJK-L 32 × SVJK-S
32SVK-ST-1.5U	1.5RU	32 × SVJK-L 32 × SVJK-S

New

Standard panel color: Black. Available in 9 colors. see page 79.

Key Features and Benefits

- 12G-SDI: SMPTE ST 2082-1 compliant
- Return loss performance: 15dB@12GHz
- 40% lighter than 32MCK-ST/32MD-ST
- 32 channels of I/O into 1RU or 1.5RU
- Canare original hassle-free patching design
- Staggered BNC rear jacks
- Can be recessed 25 mm.
- Included a sheet of channel designator for easy identification

Note: Be sure to use with Canare Single Video Patch Cords.



■ Single Video Jacks

Model	Description	Rear Jack
SVJK-L	Long type	BNC
SVJK-S	Short type	BNC

*Adapter plates: SVJK-AP should be used for loading the jacks. Call for the details.

■ Single Video Plug

Model	Suitable Cable	Boot	Die Set
SVP-C25HW	L-2.5CHWS	CB02	TCD-D253F

*Standard package: 20 pcs

■ U-link and Termination Plugs

Model	Description
SVP-ULK	U-link/Looping plug
SVP-TK	Termination plug (standard package 20 pcs)

■ Accessories

Model	Description
SVPC**	Canare SV patch cords (see page 83)
BET-BNC	BNC extraction tool (see page 47)
PH50A	Patch cord holder for SVPC**
SVJK-DC	Dust cap for SVJK (black, 10 pcs)
MJ2-M32-U-***	Unloaded panels (see page 81)

New

New

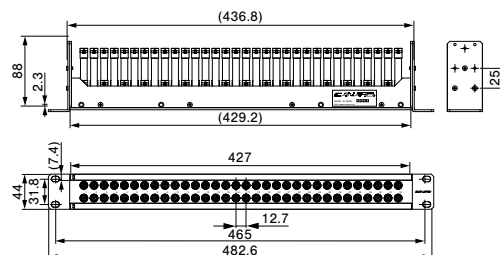
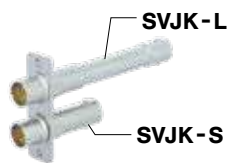
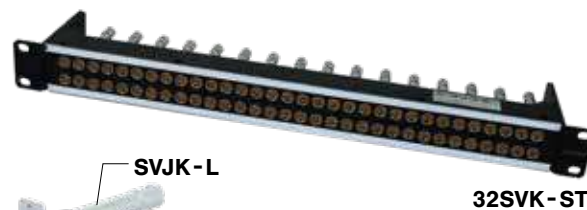

■ Return Loss

Model	SVJK-S, SVJK-L	SVP-TK	SVP-ULK
@ 3 GHz	26 dB or greater	25 dB or greater	20 dB or greater
@ 6 GHz	20 dB or greater	20 dB or greater	15 dB or greater
@ 12 GHz	15 dB or greater	10 dB or greater	10 dB or greater

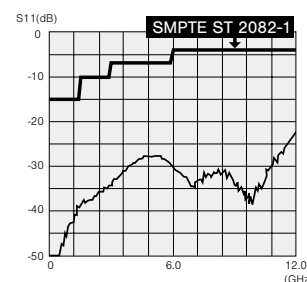
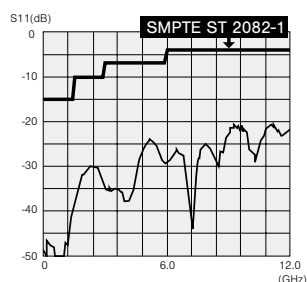
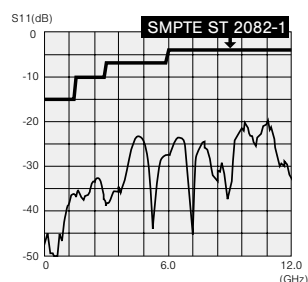
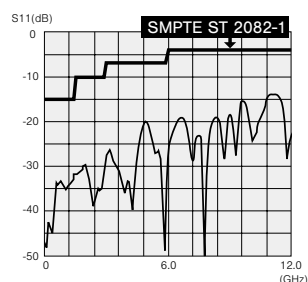

75Ω Micro Video Patchbays

Our unique, thinnest and lightest video jacks realize ultimate space efficiency.

■ Patchbays

Model	Panel Size	Loaded Video Jacks
48MC	1RU	48 × MCVJ-W
48MCS	1RU	48 × MCVJ-S

Standard panel color: Black. Available in 5 colors. Contact for more details.

Key Features and Benefits

- High density 48 channels of I/O into 1RU design.
- Video jack weights 35 g and is half of our conventional one.
- Space and weight saving; beneficial to O.B. vans
- DIN 1.0/2.3 rear jacks.
- Dust-proof shutter
- Included a sheet of channel designator for easy identification.
- Can be recessed 25 mm.
- 3G-SDI: SMPTE ST 424 compliant

Note: Be sure to use with Canare Micro Video Patch Cords.



■ Dual Video Jacks

Model	Description	Rear Jacks
MCVJ-W	Normal through	DIN 1.0/2.3
MCVJ-S	Straight through	DIN 1.0/2.3

■ Micro Video Plug

Model	Suitable Cable	Boot	Die Set
MCVP-C25HW	L-2.5CHWS	—	TCD-D253F

*Standard package: 20 pcs

*The plug is specifically designed for MCVJ and MCVJ(A) jacks.

■ Accessories

Model	Description
MCVPC**	Canare Micro patch cords (see page 83)
BCJ-MCVP New	BNC (female) to Micro Video plug conversion adapter (10 pcs)
BET-DIN	Extraction tool for DCP-C series (see page 47)
BET-D/H New	
PH50B	Patch cord holder for MCVPC**
MCVJ-DC	Dust cap for MCVJ (black, 100 pcs)

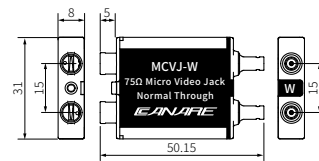
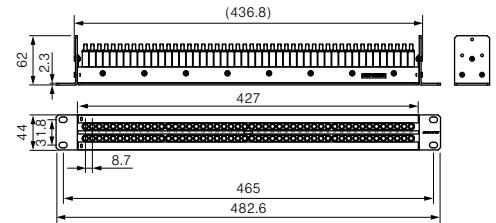

■ Return Loss & Isolation

Model	MCVJ-W	MCVJ-S
RL	DIN-DIN: Normal Through	20 dB or greater @ 3 GHz
	DIN-Video: Patch Through	20 dB or greater @ 3 GHz
	DIN-Self Termination	10 dB or greater @ 3 GHz
Isolation	45 dB or greater @ 3 GHz	45 dB or greater @ 3 GHz

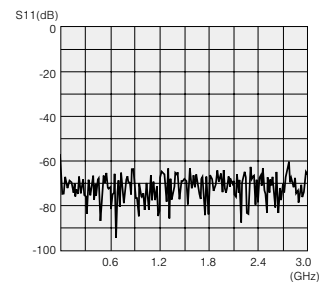
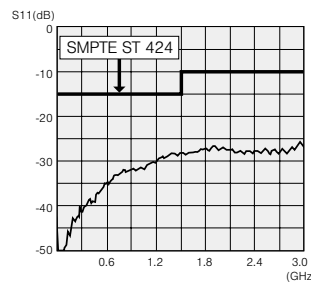
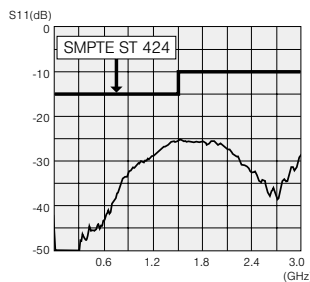

Normal Through

Patch Through

Isolation

Return Loss for MCVJ-W

Technical Trend

Fiber-Optic Systems

Connectors

Cables

Panels & Patchbays

Multichannel Systems

Cable Assemblies

Panels and Patchbays

75Ω Video Patchbays

75Ω Staggered Mid-size Video Patchbays

3G-ready mid-size video jacks allow for more efficient use of rack space.

■ Patchbays

Model	Panel Size	Loaded Video Jacks
32MD-ST	1RU	32 × MDVJ-STW
32MD-STs	1RU	32 × MDVJ-STs
32MD-ST-2U	2RU	32 × MDVJ-STW
32MD-STs-2U	2RU	32 × MDVJ-STs
32MD-ST-4U	4RU	96 × MDVJ-STW
32MD-STs-4U	4RU	96 × MDVJ-STs

Standard panel color: Black. Available in 9 colors. see page 79.

Key Features and Benefits

- 32 channels of I/O into 1 or 2RU, 96 channels of I/O into 4RU.
- Rotary Switch Technology with dual-contact construction.
- Can be recessed 25 mm (except 4RU type).
- Wide designation strip (2RU, 4RU type).
- Lightweight aluminum alloy video jacks.

Note: Be sure to use with Mini-WECO Video Patch Cords.



32MD-STs



32MD-ST-4U

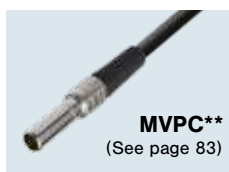

MVPC**
(See page 83)

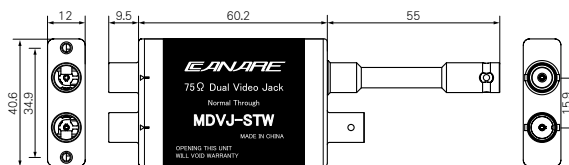

■ Dual Video Jacks

Model	Description	Rear Jacks
MDVJ-STW	Normal through, Staggered rear jacks	BNC
MDVJ-STs	Straight through, Staggered rear jacks	BNC



MVP-C4

■ Mini-WECO Video Plugs

Model	Suitable Cable	Boot	Die Set
MVP-C25HW	L-2.5CHWS	CB25	TCD-D253F
MVP-C4	LV-61S, RG-59B/U, Belden 8241, 8279, 88241	CB25	TCD-451CA TCD-4CA

*Standard package: 20 pcs

■ Accessories

Model	Description
MVPC**	Mini WECO patch cords (see page 83)
MVPC**-HW	Mini WECO patch cords (see page 83)
BCJ-MVP	BNC (female) to Mini-WECO plug conversion adapter (10 pcs)
BET-BNC	BNC extraction tool (see page 47)
PH50A	Patch cord holder for MVPC**
MVJ-DC	Dust cap for MDVJ (color: black 40 pcs)
MJ2-M32-U-***	Unloaded panels (see page 81)
VJ2-M32-4U	

*BCJ-MVP is recommended to use with Slim BNC plug (see page 30).

■ Return Loss & Isolation

Model	MDVJ-STW	MDVJ-STs
BNC-BNC: Normal Through		—
RL	BNC-Video: Patch Through	26 dB or greater @ 750 MHz 20 dB or greater @ 2.4 GHz 10 dB or greater @ 3 GHz
	BNC-Self Termination	26 dB or greater @ 750 MHz 20 dB or greater @ 1.5 GHz 10 dB or greater @ 3 GHz
	Isolation	35 dB or greater @ 1.5 GHz 20 dB or greater @ 3.0 GHz

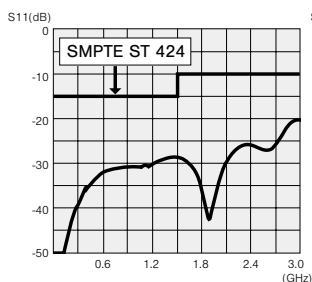

Normal Through

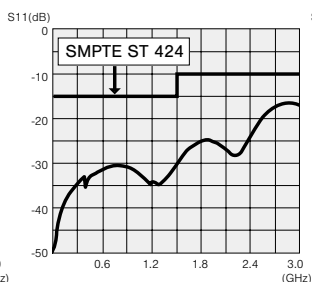

Patch Through
(Long BNC port)

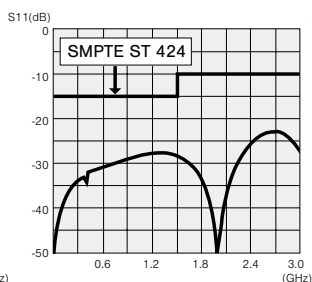

Patch Through
(Short BNC port)

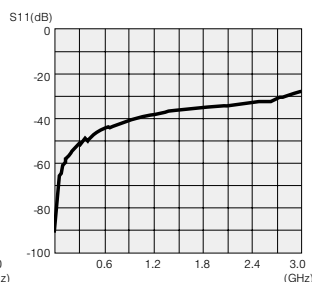

Isolation

Return loss for MDVJ-STW

75Ω Video Patchbays

3G-ready HD-SDI video patchbays featuring Canare's uniquely-developed rotary switches.

Patchbays

Model	Panel Size	Loaded Video Jacks
20DV	1RU	20 × DWJB-W
24DV		24 × DWJB-W
26DV		26 × DWJB-W
20DVS	1RU	20 × DWJB-S
24DVS		24 × DWJB-S
26DVS		26 × DWJB-S
20DV-2U	2RU	20 × DWJB-W
24DV-2U		24 × DWJB-W
26DV-2U		26 × DWJB-W
20DVS-2U	2RU	20 × DWJB-S
24DVS-2U		24 × DWJB-S
26DVS-2U		26 × DWJB-S

Standard panel color: Black. Available in 9 colors, see page 80.

Key Features and Benefits

- Rotary Switch Technology with dual-contact construction.
- Can be recessed 25 mm.
- Wide designation strip (2RU type).
- Lightweight aluminum alloy video jacks.

Note: Be sure to use with WECO Video Patch Cords.



Dual Video Jacks

Model	Description	Rear Jacks
DVJB-W	Normal through	BNC
DVJB-S	Straight through	BNC

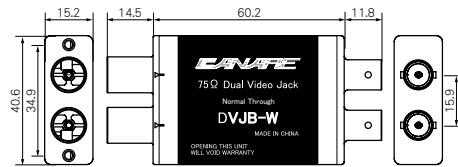

WECO Plugs

Model	Suitable Cable	Boot	Die Set
VWP-C25HW	L-2.5CHWS	CB04	TCD-D253F
VWP-C4A	LV-61S, RG-59B/U, Belden 8241, 8279, 88241	CB04	TCD-451CA TCD-4CA

*Standard package: 20 pcs



Accessories

Model	Description
VPC**-WC	WECO patch cords (see page 83)
VPC**-HW-WC	WECO patch cords (see page 83)
BCJ-VWP	BNC (female) to WECO plug conversion adapter
BET-BNC New	BNC extraction tool (see page 47)
PH50A	Patch cord holder for VPC**
VJ-DC	Duct cap for DVJB (black, 40 pcs)
VJ2-V**-*U-***	Unloaded panels (see page 81)

Return Loss & Isolation

Model	DVJB-W	DVJB-S	
RL	BNC-BNC: Normal Through	—	
	BNC-Video: Patch Through	26 dB or greater @ 750 MHz 20 dB or greater @ 2.4 GHz 10 dB or greater @ 3 GHz	26 dB or greater @ 750 MHz 20 dB or greater @ 2.4 GHz 10 dB or greater @ 3 GHz
	BNC-Self Termination	26 dB or greater @ 750 MHz 20 dB or greater @ 1.5 GHz 10 dB or greater @ 3 GHz	26 dB or greater @ 750 MHz 20 dB or greater @ 1.5 GHz 10 dB or greater @ 3 GHz
Isolation	35 dB or greater @ 1.5 GHz 20 dB or greater @ 3.0 GHz	35 dB or greater @ 1.5 GHz 20 dB or greater @ 3.0 GHz	

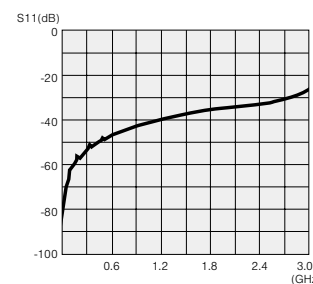
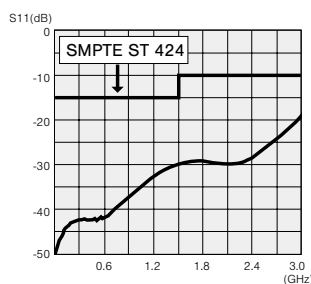
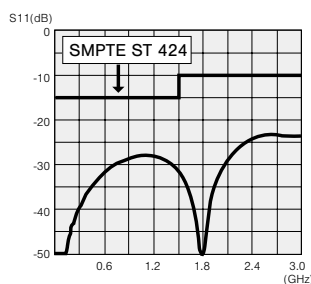

Return loss for DVJB-W

Technical Trend

Fiber-Optic Systems

Connectors

Cables

Panels & Patchbays

Multichannel Systems

Cable Assemblies

Panels and Patchbays

75Ω Video Patchbays

Ordering Information

32 Channels 12G/3G Video Patchbays

32 **MCKA** - ST **S** - 2 - 2U

Jack Type

MCKA	12G Dual
-------------	----------

Signal Path

Blank	Normal through
S	Straight through

Panel Color

Blank	Black
2	Red
4	Yellow
5	Green
6	Blue
7	Purple

Rack Unit

Blank	1RU
1.5U	1.5RU
2U	2RU

32 **MD** - ST **S** - 8 - 2U

Jack Type

SVK	12G Single
MD	3G Dual

Signal Path

Blank	Normal through
S	Straight through

Panel Color

Blank	Black
1	Brown
2	Red
3	Orange
4	Yellow
5	Green
6	Blue
7	Purple
8	Gray
9	White

Rack Unit

Blank	1RU
1.5U	1.5RU *
2U	2RU *
4U	4RU **

* 1.5RU and 2RU are available for SVK and MD.
** for 4RU, MD only.

* MD only.
* for 4RU, black only.

32MD-ST

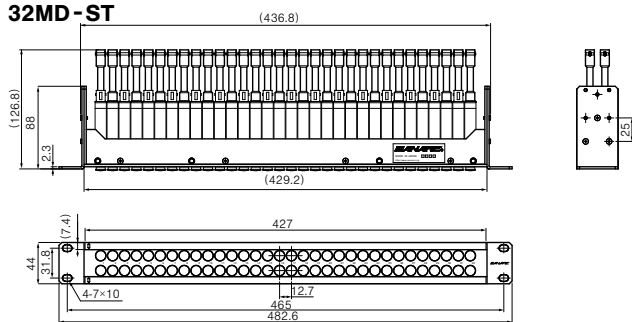

32SVK-ST-1.5U

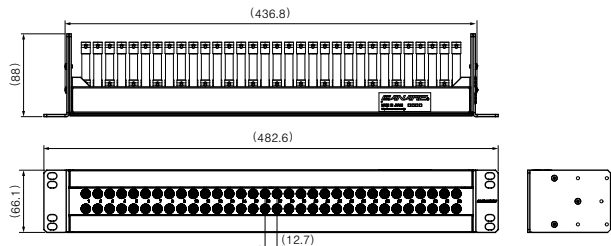

32MD-ST-2U

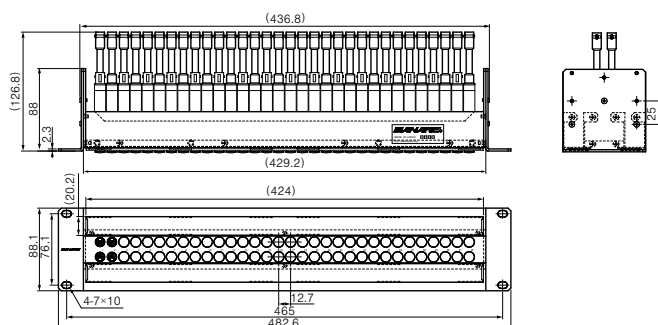

32MD-ST-4U

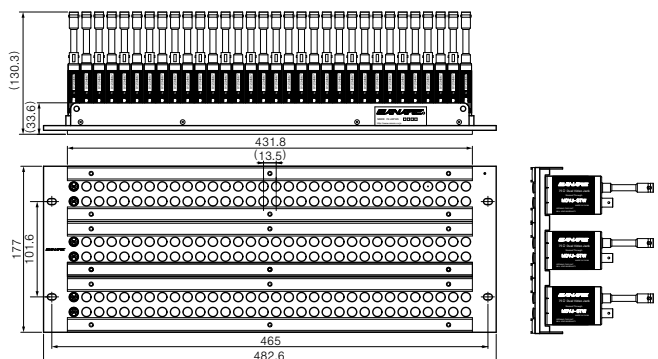

Ordering Information

WECO Video Patchbays

24 DV S - 8 - 2U

Number of Channels

20	20 Channels
24	24 Channels
26	26 Channels

Signal Path

Blank	Normal through
S	Straight through

Panel Color

Blank	Black
1	Brown
2	Red
3	Orange
4	Yellow
5	Green
6	Blue
7	Purple
8	Gray
9	White

Rack Unit

Blank	1RU
2U	2RU

20DV

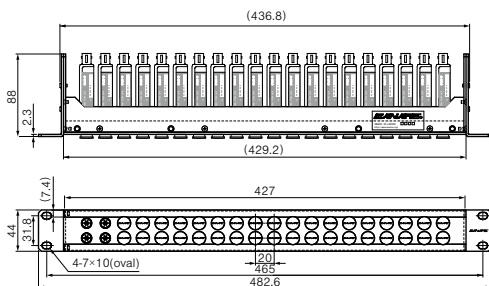

24DV

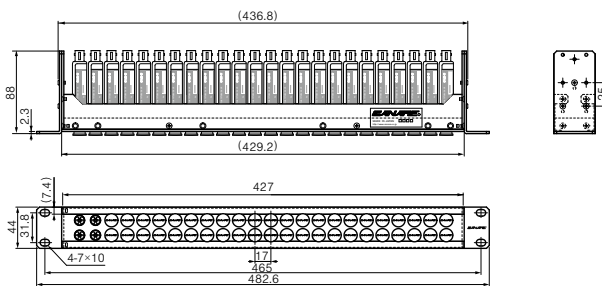

26DV-2U

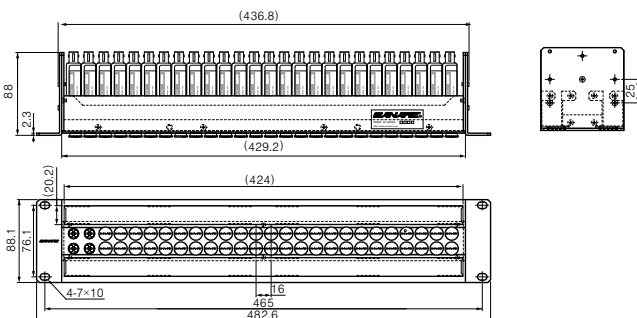

Designation Strip Dimensions

- 1RU : 426 mm × 6.2 mm
- 1.5RU: 426.5 mm × 16.7 mm
- 2RU : 420 mm × 18.4 mm
- 4RU : 431.8 mm × 13.2 mm

Note:

- 1) 4RU type is available in black color only.
- 2) 4RU type can not be recessed.

Technical Trend
Fiber-Optic Systems
Connectors
Cables
Panels & Patchbays
Multichannel Systems
Cable Assemblies

Panels and Patchbays

Unloaded Video Jack Panels

Unloaded Video Jack Panels

Model	Panel Size	Description
VJ2-V20-1U-***	1RU	20 ch (40 holes), for DVJB
VJ2-V20-2U-***	2RU	20 ch (40 holes), for DVJB
VJ2-V24-1U-***	1RU	24 ch (48 holes), for DVJB
VJ2-V24-2U-***	2RU	24 ch (48 holes), for DVJB
VJ2-V26-1U-***	1RU	26 ch (52 holes), for DVJB
VJ2-V26-2U-***	2RU	26 ch (52 holes), for DVJB
MJ2-M32-1U-***	1RU	32 ch (64 holes), for MDVJ and SVJK
MJ2-M32-1.5U-*** New	1.5RU	32 ch (64 holes), for MDVJ and SVJK
MJ2-M32-2U-***	2RU	32 ch (64 holes), for MDVJ and SVJK
VJ2-M32-4U	4RU	96 ch (3 × 32 ch, 192 holes), for MDVJ, Black
MJ2-M32CKA-1U-*** New	1RU	32 ch (32 slots), for MCVJKA
MJ2-M32CKA-1.5U-*** New	1.5RU	32 ch (32 slots), for MCVJKA
MJ2-M32CKA-2U-*** New	2RU	32 ch (32 slots), for MCVJKA

***: Please refer to the ordering information below.

<Ordering Information>

Mid-Size 3G/12G Video Patchbays

* for 4RU, one model only: VJ2-M32-4U

MJ2 - M32 - **1U** - **BLK**

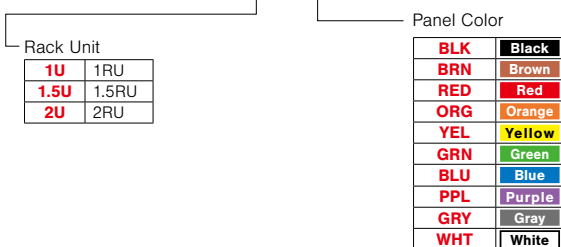

MJ2 - M32 **CKA** - **1.5U** - **BLK**

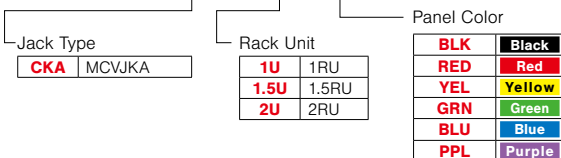

MJ2-M32CKA

WECO Video Patchbays

VJ2 - V **24** - **1U** - **BLK**

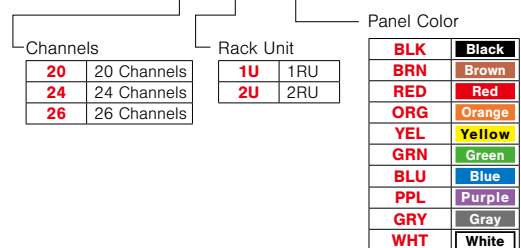

Designation Strip Dimensions

- 1RU : 426 mm × 6.2 mm
- 1.5RU : 426.5 mm × 16.7 mm
- 2RU : 420 mm × 18.4 mm
- 4RU : 431.8 mm × 13.2 mm

Note :

- 1) 4RU type is available in black color only.
- 2) 4RU type can not be recessed.

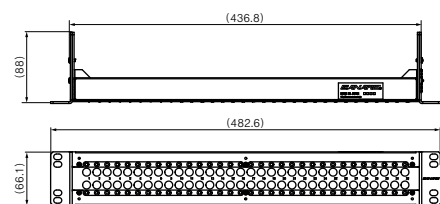

MJ2-M32-1.5U-BLK

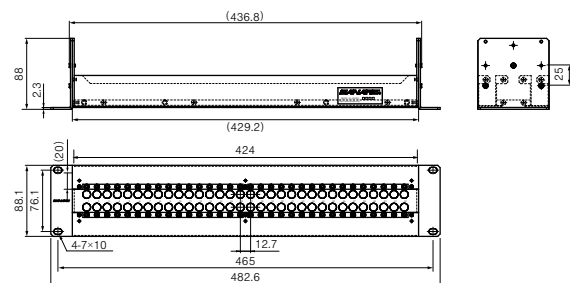

MJ2-M32-2U-BLK

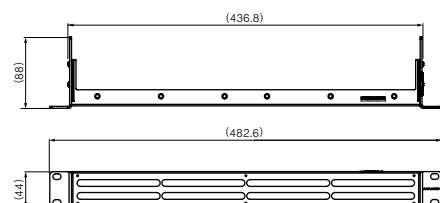

MJ2-M32CKA-1U-BLK

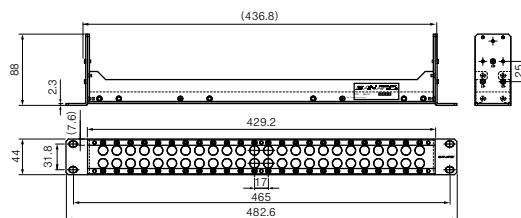

VJ2-V24-1U-BLK

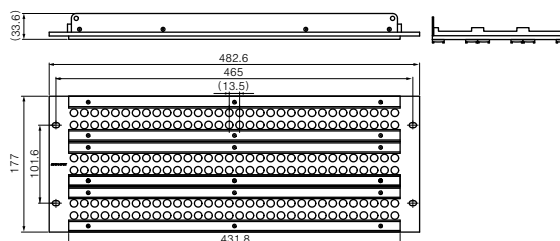

VJ2-M32-4U

RS422 Patchbays

Model	Panel Size	Connectors	
		Front Panel	Rear Panel
RS-422-1U-16	1RU	Bantam	D sub 9P(F) × 16
RS-422-1U-24	1RU	Bantam	D sub 9P(F) × 24
RS-422-2U-32	2RU	Bantam	D sub 9P(F) × 32
RS-422-2U-48	2RU	Bantam	D sub 9P(F) × 48

- The RS422 serial signal used for VTR remote applications can now be switched with Bantam patchbay ease.
- D sub screws are M2.6

* Listed above items are other manufacturer's products.



RS-422-2U-48

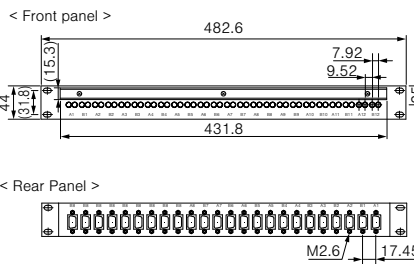
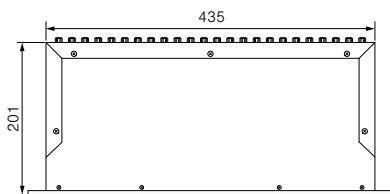
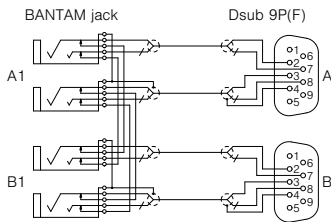

RS-422-1U-24

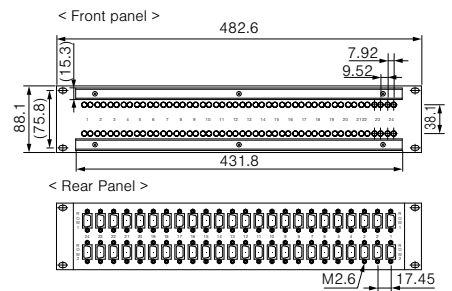

RS-422-2U-48

Technical Trend

Fiber-Optic Systems

Connectors

Cables

Panels & Patchbays

Multichannel Systems

Cable Assemblies

Panels and Patchbays

Video Patch Cords

Video Patch Cords

Canare Micro

For 32MCKA-ST or 48MC

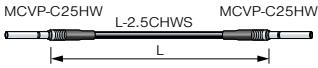
Type	Model	Length (m)
 MCVP-C25HW L-2.5CHWS MCVP-C25HW L	MCVPC003	0.3
	MCVPC005	0.5
	MCVPC01	1

BLK BRN RED YEL GRN BLU PPL

Canare Micro



Canare Single

For 32SVK

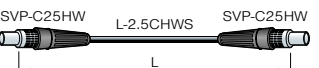
Type	Model	Length (m)
 SVP-C25HW L-2.5CHWS SVP-C25HW L	SVPC003	0.3
	SVPC005	0.5
	SVPC01	1

BLK BRN RED YEL GRN BLU PPL

Canare Single



Mini-WECO

For 32MD-ST and Mini-WECO patchbays

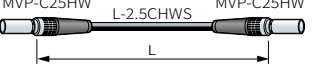
Type	Model	Length (m)
 MVP-C4 LV-61S MVP-C4 L	MVPC003	0.3
	MVPC005	0.5
	MVPC01	1
 MVP-C25HW L-2.5CHWS MVP-C25HW L	MVPC003-HW New	0.3
	MVPC005-HW New	0.5
	MVPC01-HW New	1

BLK RED YEL GRN BLU

BLK BRN RED YEL GRN BLU PPL

Mini-WECO



WECO

For 2*DV and WECO patchbays

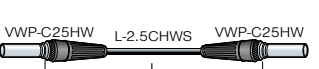
Type	Model	Length (m)
 VWP-C4A LV-61S VWP-C4A L	VPC003-WC	0.3
	VPC005-WC	0.5
	VPC01-WC	1
 VWP-C25HW L-2.5CHWS VWP-C25HW L	VPC003-HW-WC New	0.3
	VPC005-HW-WC New	0.5
	VPC01-HW-WC New	1

BLK BRN RED ORN YEL GRN BLU PPL GRY WHT

BLK BRN RED YEL GRN BLU PPL

WECO



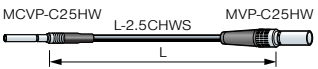
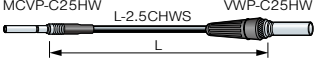
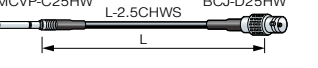

Canare Micro Conversion

Type	Model	Length (m)
to Mini-WECO  MCVP-C25HW L-2.5CHWS MVP-C25HW L	MCVPC003-MVP	0.3
	MCVPC005-MVP	0.5
	MCVPC01-MVP	1
to WECO  MCVP-C25HW L-2.5CHWS VWP-C25HW L	MCVPC003-VWP	0.3
	MCVPC005-VWP	0.5
	MCVPC01-VWP	1
to BNC (F)  MCVP-C25HW L-2.5CHWS BCJ-D25HW L	MCVPC002-BJ	0.2

BLK BRN RED YEL GRN BLU PPL

BLK BRN RED YEL GRN BLU PPL

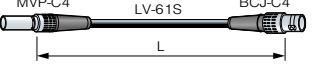
Mini-WECO Conversion

Type	Model	Length (m)
to BNC (F)  MVP-C4 LV-61S BCJ-C4 L	MVPC002-BJ	0.2
to BNC (M)  MVP-C4 LV-61S BCP-A4 L	MVPC02A-BP	2
	MVPC05A-BP	5

BLK RED YEL GRN BLU

BLK RED YEL GRN BLU

Pre-Loaded A/V Connector Panels

Key Features and Benefits

- BNC and XLR types are available.
- Clear plastic cover, full screen desi-strip
- Variety of panel options
- Most popular panel holes XLR F77 and Neutrik D available

XLR Connector Panels

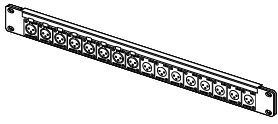
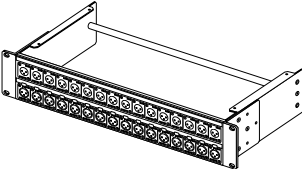
Type	Panel Size	Model	Loaded Connector	Panel P/N	Dimensions (mm)
 <p>161U-X12F</p>	1RU	161U-X1F	XLR3-31-F77 (16 pcs)	1U-AS1	44 × 482.6 × 39.7
		161U-X2F	XLR3-32-F77 (16 pcs)		44 × 482.6 × 26.6
		161U-X12F	XLR3-31-F77 (8 pcs, Left) XLR3-32-F77 (8 pcs, Right)		44 × 482.6 × 39.7
		161U-B1	NC3FD-LX-B (16 pcs)	1U-AS1D	44 × 482.6 × 31.3
		161U-B2	NC3MD-LX-B (16 pcs)		44 × 482.6 × 23.6
 <p>162U-X21</p>	2RU	162U-X21	XJ3M-P3FA (16 pcs, Upper Row) XJ3F-P3MA (16 pcs, Lower Row)	2U-AS7	88.1 × 482.6 × 217
		162U-X22	XJ3M-P3FA (32 pcs, 2 rows)		

BNC Connector Panels

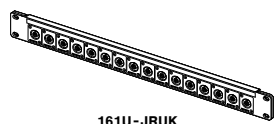
Type	Panel Size	Model	Loaded Connector	Panel P/N	Dimensions (mm)
 <p>161U-JRUK</p>	1RU	161U-JRUK	BCJ-JRUK (16 pcs)	1U-AS1	44 × 482.6 × 31.4
		161U-JRUDB	BCJ-JRUDB (16 pcs)	1U-AS1D	44 × 482.6 × 29.1
	2RU	162U-JRUK	BCJ-JRUK (32 pcs, 2 rows)	2U-AS7	88.1 × 482.6 × 217

XLR3 Panel Mount Adapters

Model	Description		Flange Type
	Front	Rear	
XJ3M-P3FA	XLR 3pin (M)	XLR 3pin (F)	ITT XLR-F77
XJ3M-P3MA	XLR 3pin (M)	XLR 3pin (M)	
XJ3F-P3FA	XLR 3pin (F)	XLR 3pin (F)	
XJ3F-P3MA	XLR 3pin (F)	XLR 3pin (M)	

- XJ3 series are XLR3 full compatible.
- XLR jack to jack extremely reduce installation hours.

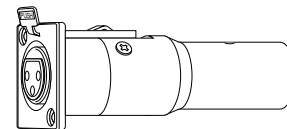

XJ3F-P3MA

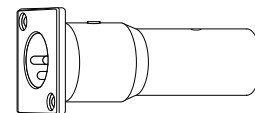

XJ3M-P3MA

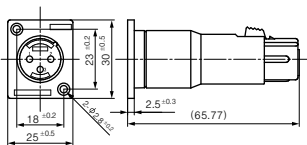

XJ3M-P3FA

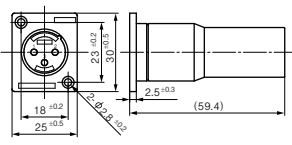

XJ3M-P3MA

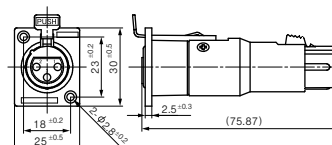

XJ3F-P3FA

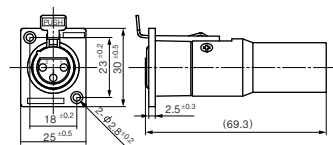

XJ3F-P3MA

Blank Panels

Model	Description
BP-DXF (20 pcs)	Snap-on blank panels for both ITT XLR-F77/Neutrik D holes
BP-XF (10 pcs)	Blank panels for ITT XLR-F77 hole with screws
BP-D (10 pcs)	Blank panels for Neutrik D hole with screws

BP-DXF

- Easy and quick snap-on mounting without any tools
- Can be used for both ITT XLR-F77 and Neutrik D holes

Note: Panel thickness range: t 1.2 to t 2.3 mm



BP-DXF

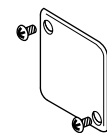

BP-XF

Technical Trend

Fiber-Optic Systems

Connectors

Cables

Panels & Patchbays

Multichannel Systems

Cable Assemblies

Panels and Patchbays

Connector Panels

Unloaded A/V Connector Panels

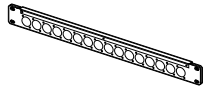
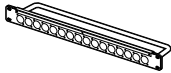
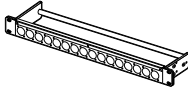
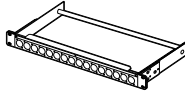
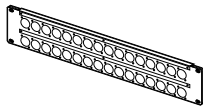
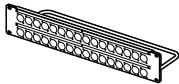
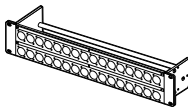
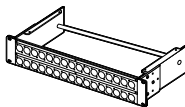
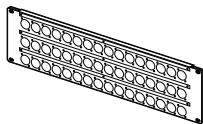
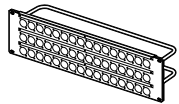
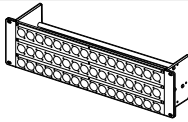
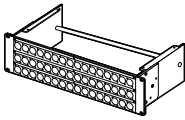
Panel Type	AS1 (D)	AS3 (D)	AS5 (D)	AS7 (D)
Description	Flat panel	Flat panel w/cable tie bar	Variable panel w/cable tie bar short type	Variable panel w/cable tie bar Long type
1RU 16 holes × 1 row				
Model	1U-AS1 (D)	1U-AS3 (D)	1U-AS5 (D)	1U-AS7 (D)
Depth (mm)	—	64.8	100	217
2RU 16 holes × 2 rows				
Model	2U-AS1 (D)	2U-AS3 (D)	2U-AS5 (D)	2U-AS7 (D)
Depth (mm)	—	64.8	100	217
3RU 16 holes × 3 rows				
Model	3U-AS1 (D)	3U-AS3 (D)	3U-AS5 (D)	3U-AS7 (D)
Depth (mm)	—	64.8	100	217

Variable panel can be recessed 25 mm.

Ordering Information

Panel Height,

Number of holes and Rows

1U	1RU, 16 holes, 1row
2U	2RU, 32 holes, 2rows
3U	3RU, 48 holes, 3rows

1U - **AS3** **D** — Hole Type

Blank ITT XLR-F77 Type

D Neutrik D Type

Panel Type

AS1	Flat panel
AS3	Flat panel w/ cable tie bar
AS5	Variable panel w/ cable tie bar - short depth
AS7	Variable panel w/ cable tie bar - long depth

Note: Depending on their length, some connectors can not be mounted on the panel with a cable tie bar installed.

Related Products

Model	Description
M-MA1U02A New	1RU mounting brackets for a Variable panel, 2 pcs. (left and right)
M-MA2U02	2RU mounting brackets for a Variable panel, 2 pcs. (left and right)
M-MA3U02	3RU mounting brackets for a Variable panel, 2 pcs. (left and right)
DS10-AS4	Designation strip for Canare A/V connector panels, 2 pcs.

Examples of Custom-Made Connector Panels

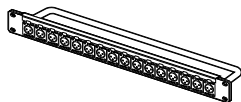

1U-AS3 + XLR3-31-F77 × 16

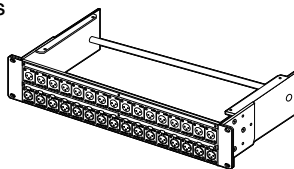

2U-AS7 + XLR3-32-F77 × 16
XLR3-31-F77 × 16

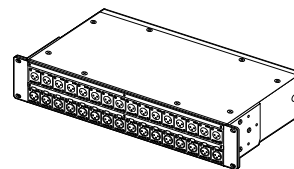

2U-AS7 (box type)
Connectors can be mounted on the both side.

Connectors Canare Flush-mount BNC, F, RCA and XLR (ITT XLR-F77 or Neutrik D type) are available.

Options

- A) Rear Panel A connector panel can be mounted on the rear.
- B) Box Type A connector panel, top plate and bottom plate can be mounted on the rear.
- C) Recessed Variable panel can be recessed 25 mm by changing the screw positions of the mounting brackets and can be recessed either 50 mm or 75 mm by changing the mounting brackets to M-MA1U02A or M-MA*U02.

Options	AS1 (D)	AS3 (D)	AS5 (D)	AS7 (D)
A) Rear Panel	N/A	N/A	Available	Available
B) Box Type	N/A	N/A	N/A	Available
C) Recessed	N/A	N/A	Available	Available

Audio Patchbays

The gold alloy cross bar contact, which features a low faulty contact rate, is used for the jacks.

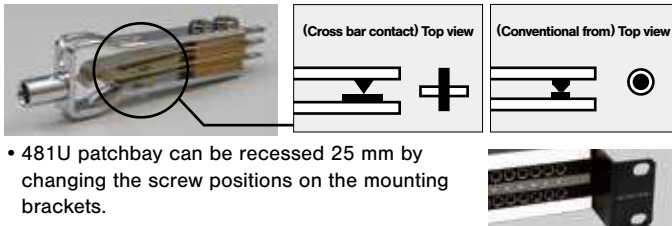

- 481U patchbay can be recessed 25 mm by changing the screw positions on the mounting brackets.

Model	Description	Connector
481U - 820AQ	Bantam Patchbay	820AQ × 96

Model	Description	Connector
48 - 12A/820AQ/EIA	Bantam Patchbay	820AQ × 96
32 - 12A/620A/EIA	Skini Patchbay	620A × 64
612A/320A/EIA	Maxi Patchbay	320A × 52

* Listed above items are other manufacturer's products.



Bantam patch panel 481U-820AQ



Bantam patch panel 48-12A/820AQ/EIA



BC * M
(See page 98 for patch cords.)

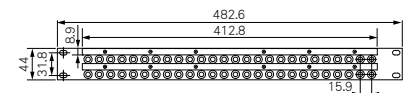
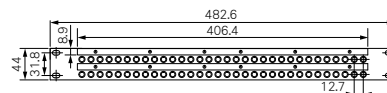
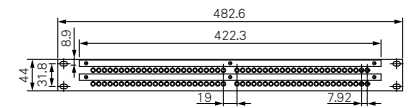
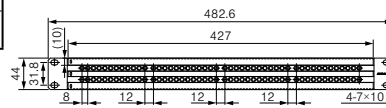

Audio Patchbays Related Products

Model	Description
320A	Maxi Jack
620A	Skini Jack
820AQ	Bantam Jack
ABJ-DC	Bantam Jack Dust Cap (100 pcs/pkg)
NP3TMC-B	Maxi/Skini Plug
ABP-DP New	Bantam Dummy Plug (10 pcs.)
PH50A	Maxi/Skini/Video Patch Cord Holder
PH50B	Bantam Patch Cord Holder
DS10-AS1	Designation Strip for Bantam (2 pcs.)
DS10-AS2	Designation Strip for Skini (2 pcs.)
DS10-AS3	Designation Strip for Maxi (2 pcs.)

* Listed above items are other manufacturer's products.

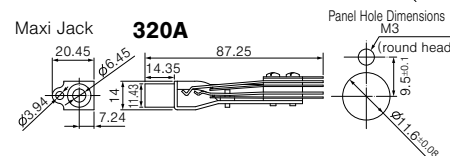
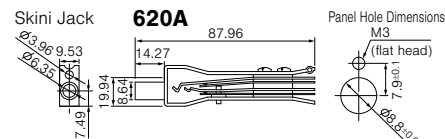
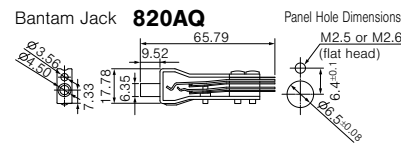

Patch Cord Holder

Capable up to 50 patch cords.
Easy to install on the wall or side of rack.
PH50A for Maxi/Skini, Video cords.
PH50B for Bantam cords.

Technical Note

Audio Patchbay Normalling Descriptions

Output from a device is obtained from the upper row, while input to a device is normally connected to the lower row.

Users can select from the following three types of connecting functions.

<Wiring formats connecting upper and lower connectors>

F: Full normal connection

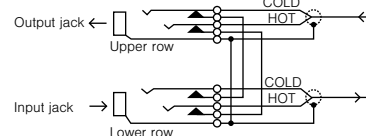

Full Normal Format (series)

The upper (output) row is connected to the lower row (input) in the state when a plug is not inserted.
When a plug is inserted in the upper jack to obtain a signal, the signal is not connected to the lower jack. A signal can be entered by inserting a plug in the lower jack. In this case the signal is not connected to the upper jack.

H: Half normal connection

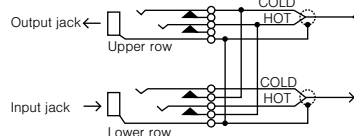

Half Normal Format (half-parallel)

The upper (output) row is connected to the lower row (input) in the state when a plug is not inserted.
When a plug is inserted in the upper jack to obtain a signal, the signal is connected to the lower jack. This format allows the signal to be obtained in parallel. The signal can be prevented from going to the lower jack by inserting a dummy plug.
Signals are input by inserting a plug in the lower jack. In this case the signal is not connected to the upper jack.

W: Double normal connection

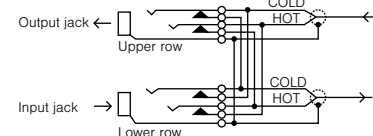

Double Normal Format (series-parallel)

The upper (output) row is connected to the lower row (input) in the state when a plug is not inserted.
When a plug is inserted in the upper jack to obtain a signal, the signal is connected to the lower jack. This format allows the signal to be obtained in parallel. The signal can be prevented from going to the lower jack by inserting a dummy plug.
A signal can be entered by inserting another plug in the lower jack. Note that the signal in this case is connected to the upper jack.
This can be prevented by inserting a dummy plug.

Panels and Patchbays

Audio Patchbays

Wired Box

Type	Model	Size	Connector	
			Front	Rear
Bantam	481U-WBF	1RU	820AQ × 96	90-602 × 4
	481U-WBH	1RU	820AQ × 96	90-602 × 4
	481U-WBW	1RU	820AQ × 96	90-602 × 4
	481U-WBS	1RU	820AQ × 96	90-602 × 4
	48WB-F	1RU	820AQ × 96	90-602 × 4
	48WB-H	1RU	820AQ × 96	90-602 × 4
	48WB-W	1RU	820AQ × 96	90-602 × 4
Skini	32WB-F	1RU	620A × 64	90-602 × 4
	32WB-H	1RU	620A × 64	90-602 × 4
	32WB-W	1RU	620A × 64	90-602 × 4
Maxi	26WB-F	1RU	320A × 52	90-602 × 4
	26WB-H	1RU	320A × 52	90-602 × 4
	26WB-W	1RU	320A × 52	90-602 × 4

481U-WB can be recessed 25 mm
 *90-602 connector is identical to
 ELCO 00-8016-090-***-702V connector

90-602



Bantam wired box **481U-WB***



Bantam wired box **48WB-***



Maxi wired box **26WB-***



Skini wired panel **32XP-***

Wired Panels

Type	Model	Panel 1		Panel 2	
		Size	Connector	Size	Connector
Bantam	48XP-F	1RU	820AQ × 96	3RU × 2	XLR3-31-F77 × 48 XLR3-32-F77 × 48
	48XP-H	1RU	820AQ × 96	3RU × 2	XLR3-31-F77 × 48 XLR3-32-F77 × 48
	48XP-W	1RU	820AQ × 96	3RU × 2	XLR3-31-F77 × 48 XLR3-32-F77 × 48
Skini	32XP-F	1RU	620A × 64	4RU	XLR3-31-F77 × 32 XLR3-32-F77 × 32
	32XP-H	1RU	620A × 64	4RU	XLR3-31-F77 × 32 XLR3-32-F77 × 32
	32XP-W	1RU	620A × 64	4RU	XLR3-31-F77 × 32 XLR3-32-F77 × 32

*Cables are 2 meters in length.

Normalizing Options

481U-WB* — F: Full normal
 48WB-* — H: Half normal
 48XP-* — W: Double normal
 — S: Single (No normal)



TCB**

(See page 98 or patch cords)

90-602 Connector Format (Wired box)

<Rear panel>

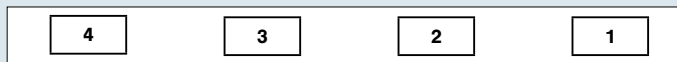

Model	Lower row	Upper row	Lower row	Upper row
Bantam	25~48 ch	25~48 ch	1~24 ch	1~24 ch
Skini	17~32 ch	17~32 ch	1~16 ch	1~16 ch
Maxi	14~26 ch	14~26 ch	1~13 ch	1~13 ch

90-602 connector is mated with 90-608 connector.
 90-608 requires either 125 or 525 contact and 90-T cover for assembling.

<Wired box side>

<Cable side>

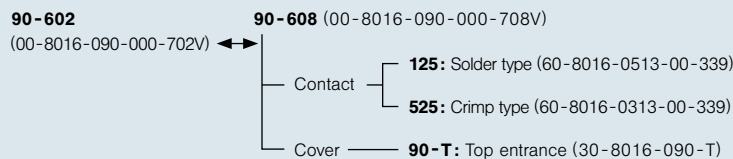

*The numbers in parentheses are ELCO ordering codes.
 ** Contact extraction tool: 06-1877-04.
 Crimping pliers for 525: 06-1001-015 (AWG #18), 06-1001-016 (AWG #20-#22), 06-1001-017 (AWG #24-#26).

Wiring Table for 90-602

Channel no.	Maxi		Skini		Bantam		HOT	COLD	SHIELD
	1	2	1	2	1	2			
1	14	1	17	1	25	A	H	R	
2	15	2	18	2	26	B	J	S	
3	16	3	19	3	27	C	K	T	
4	17	4	20	4	28	D	L	U	
5	18	5	21	5	29	E	M	V	
6	19	6	22	6	30	F	N	W	
7	20	7	23	7	31	X	AE	AM	
8	21	8	24	8	32	Y	AF	AN	
9	22	9	25	9	33	Z	AH	AP	
10	23	10	26	10	34	AA	AJ	AR	
11	24	11	27	11	35	AB	AK	AS	
12	25	12	28	12	36	AC	AL	AT	
13	26	13	29	13	37	BJ	BS	BY	
			14	30	14	38	BK	BT	BZ
			15	31	15	39	BL	BU	CA
			16	32	16	40	BM	BV	CB
					17	41	BN	BW	CC
					18	42	BP	BX	CD
					19	43	CF	CN	CW
					20	44	CH	CP	CX
					21	45	CJ	CR	CY
					22	46	CK	CS	CZ
					23	47	CL	CT	DA
					24	48	CM	CU	DB