

## About CanaBridge

*The professionals' choice*

A sub brand "CanaBridge" is established by Canare. Providing simple and affordable solutions of video signals, bridging long lasting Canare users between new generation of SNS video creators.

CanaBridge video converters will give you smart move on HDMI, 3G-SDI, and 12G-SDI interconnects. Canare engineers its development and quality verification. All CanaBridge products are equipped with light weight and sleek aluminum chassis.

## CanaBridge **5** Identities

### **01** *Superb Combination*

We raised the bar on mini converters solutions. CanaBridge converters connected with Canare products are superb combination.

### **02** *Professional Support*

Canare is here to assist you all the time. All CanaBridge products include one-year hassle free exchange program. In addition, We will provide the best sales support as well as after sale service.

### **03** *Stable Performance*

CanaBridge converters will deliver stable performance even under demanding environments. It meets your expectation without any surprises.

### **04** *Fully Engineered*

Canare engineers invest engineering effort and whole enthusiasm into CanaBridge products. Verified technical accuracies and put it into original aluminum case.

### **05** *Solid*

CanaBridge has been looking at cutting-edge technologies, appropriate materials, and standardized processes.

CanaBridge

*Lifetime Support*  
CanaBridge 5 Identities Guarantees

**5** CanaBridge  
Identities Guarantees 

# Video Converters

CanaBridge

## 12G-SDI Solutions

### CB-1120 (TX and RX) New

12G-SDI Fiber Optic Extender

#### Key Features and Benefits

- 12G/6G/3G-SDI input & loopout on transmitter
- Dual 12G-SDI outputs on receiver
- Supports up to 12G bandwidth
- SDI input automatic switching SD, HD, 3G, 6G, 12G-SDI
- 10km transmission distance



12G-SDI

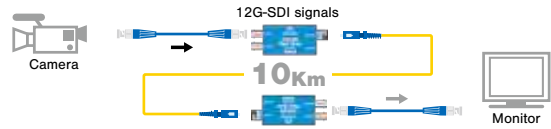

CB-1120-TX

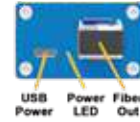
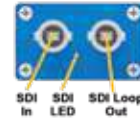

CB-1120-RX

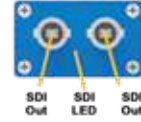
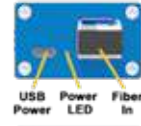

#### Specifications

Model	CB-1120 (TX and RX)
Power	Micro USB
Power Consumption	2.0W (Max)
Voltage Range	USB 3.3-5.5 V
Dimension	72.4 × 41 × 24.6 mm
Net Weight	Transmitter: 115 g, Receiver: 115 g
Gross Weight	960g

### CB-8130 New

12G-SDI 1 × 5 Reclocking Distribution Amplifier

#### Key Features and Benefits

- 12G/6G/3G/HD/SD-SDI multi-rate signal processing
- 5 buffered and re-clocked outputs
- Support DVB-ASI signal (OUT1, 4, 5)
- Automatic cable equalization and signal retiming
- All ancillary data is passed to the outputs



12G-SDI

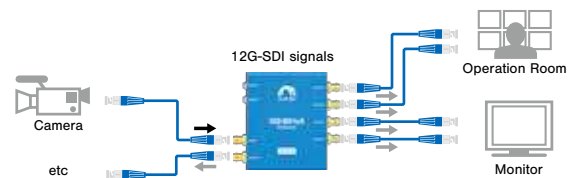

#### Specifications

Model	CB-8130
Power Supply	Threaded locking DC connector
Voltage Range	DC 6-23 V
Power Consumption	3W (Max)
Dimension	125.5 × 102 × 27.5 mm
Net Weight	310 g
Gross Weight	950 g

*Lifetime Support*

*CanaBridge 5 Identities Guarantees*

**5** CanaBridge Identities Guarantees

### 3G-SDI Solutions

**CB-2011**  
3G-SDI to HDMI mini Converter

**CB-2012**  
HDMI to 3G-SDI mini Converter

**Key Features and Benefits**

- Being made for Broadcast equipment
- Powered Anywhere
- Pocket Size and Easy to Mount

**Specifications**

Model	CB-2011	CB-2012
Power	Micro USB	
Power Consumption	2.5W (Max)	2W (Max)
Voltage Range	USB 3.3-5.5 V	
Dimension	72.4 × 41 × 24.6 mm	
Net Weight	110 g	
Gross Weight	470 g	

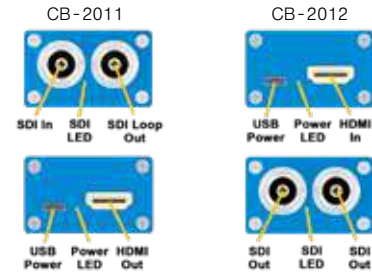
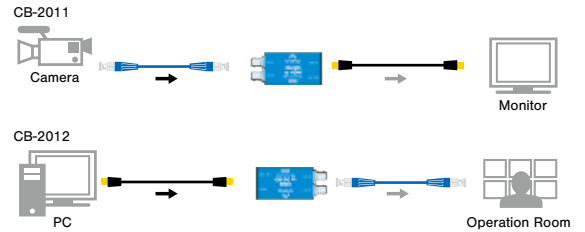

**CB-2021**  
3G-SDI to HDMI & AV Scaling Converter

**Key Features and Benefits**

- Up/down scaling and frame rate conversion
- AES/EBU or Analog Audio Embedding & De-embedding
- Input signal automatic detection and configuration
- LED indicators for power and signal lock



**Specifications**

Model	CB-2021
Power	Threaded locking connector
Power Consumption	6W (Max)
Voltage Range	DC 6-24 V
Dimension	125.5 × 101.4 × 27.5 mm
Net Weight	310 g
Gross Weight	995 g

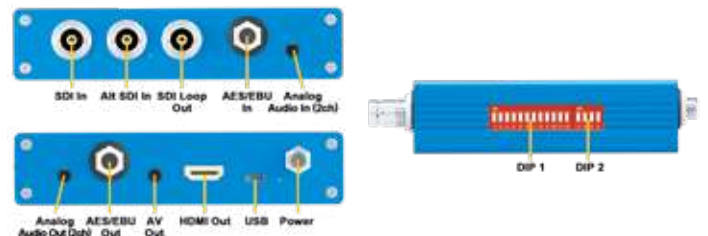
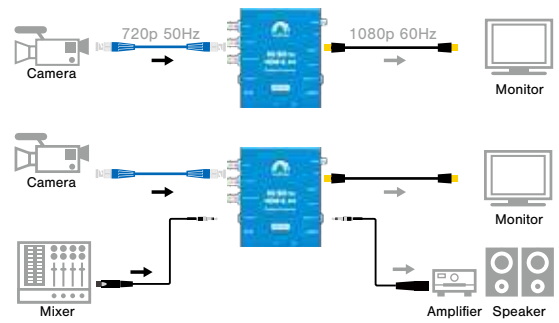

**CB-2022**  
HDMI & AV to 3G-SDI Scaling Converter

**Key Features and Benefits**

- Up/down scaling and frame rate conversion
- AES/EBU or Analog Audio Embedding & De-embedding
- Input signal automatic detection and configuration
- LED indicators for power and signal lock



**Specifications**

Model	CB-2022
Power	Threaded locking connector
Power Consumption	6W (Max)
Voltage Range	DC 6-15 V
Dimension	125.5 × 101.4 × 27.5 mm
Net Weight	310 g
Gross Weight	995 g

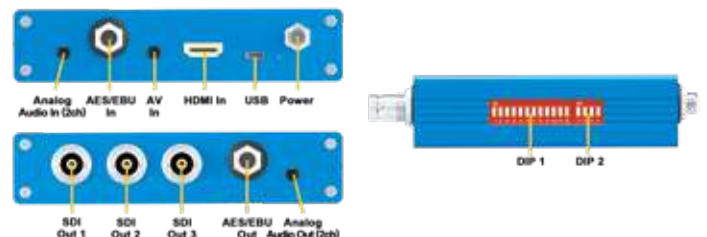
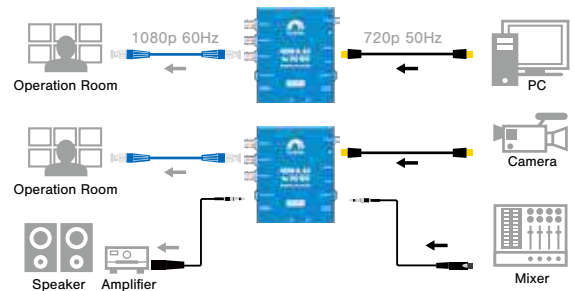

# Video Converters

CanaBridge

## 3G-SDI Solutions

### CB-8010

3G-SDI 1 × 4 Distribution Amplifier

#### Key Features and Benefits

- Automatically detects SD, HD and 3G-SDI
- 4 buffered and re-clocked outputs
- 3G/HD/SD-SDI multi-rate signal processing
- Output 2 & 4 support DVB-ASI signal
- Automatic cable equalization and signal retiming



#### Specifications

Model	CB-8010
Power	Micro USB or Threaded locking DC connector
Power Consumption	1.5W (Max)
Voltage Range	USB 5V, DC 5-17 V
Dimension	125.5 × 101.4 × 27.5 mm
Net Weight	310 g
Gross Weight	920 g

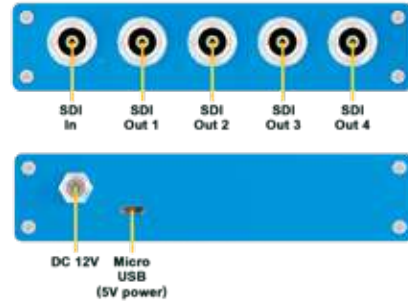
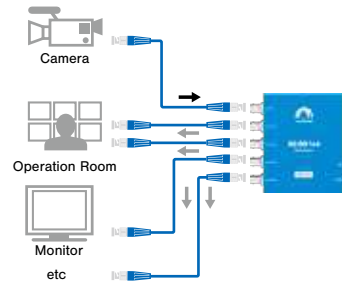

### CB-1010 (TX and RX)

3G-SDI Fiber Optic Extender

#### Key Features and Benefits

- 20km transmission distance
- Support 3Gbit Level A and Level B (all formats)
- SFP/LC Fiber transmitter & receiver
- SDI equalization and re-clocking
- 3G-SDI input & loopout on transmitter

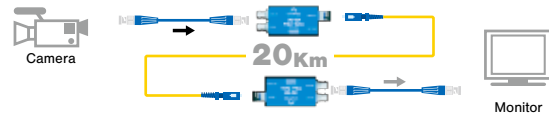

#### Specifications

Model	CB-1010 (TX and RX)
Power	Micro USB
Power Consumption	1.5W (Max)
Voltage Range	USB 3.3-5.5 V
Dimension	72.4 × 41 × 24.6 mm
Net Weight	Transmitter: 115 g, Receiver: 115 g
Gross Weight	750 g

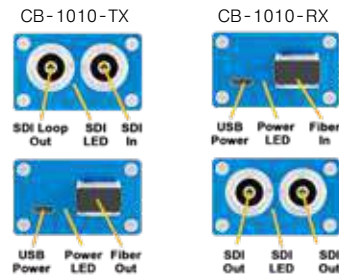

Lifetime Support

CanaBridge 5 Identities Guarantees

5 CanaBridge Identities Guarantees

